

6FKRWWN\ %ULGJH 5HFWLILHU

0D[LPX5PDWLQ0G0HFWFKD0DFWHULVWLFV
5DWLQWf&DPELMQW SHUXDQXUMKHUZHVLILHG



RATINGS AND CHARACTERISTICS CURVES

3HDN)RUZDUG 6XUDJH &XUUHQW \$QVWDQHRXV)RUZDUG &XUUHQW \$YHUDJH 5HFWLILHG 2XWSXW &XUUHQW

-XQFWLRQ &DSDFLWDQFH S) ,QVWDQHRXV 5HYHUH \$XUUHQW)LJ 7\SLFDO 5HYHUH &KDUDFWHULVWLF

)LJ \$YHUDJH 5HFWLILHG 2XWSXW &XUUHQW)LJ 7\SLFDO 5HYHUH &KDUDFWHULVWLF

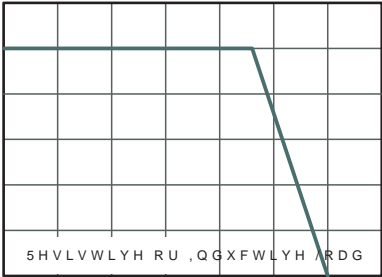

&DVH 7HPSHUDWXUH °&

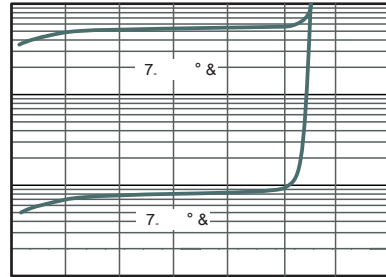

SHUFHQW R3IHDDW5HG YHUVH 9ROWDJH

)LJ 7\SLFDO ,QVWDQHRXV)RUZDUG &KDUDFWHULVWLF

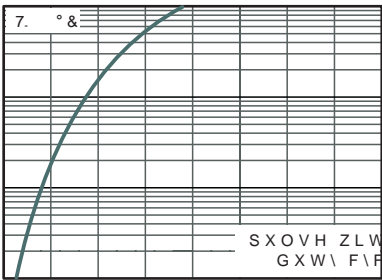

,QVWDQHRXV)RUZDUG 9ROWDJH 9

)LJ 7\SLFDO -XQFWLRQ &DSDFLWDQFH

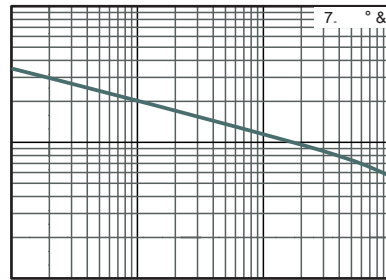

5HYHUH 9ROWDJH 9

)LJ 0D[LXP 1RQ 5HSHWLWLYH 3HDN)RUZDUG 6XUDJH &XUUHQW

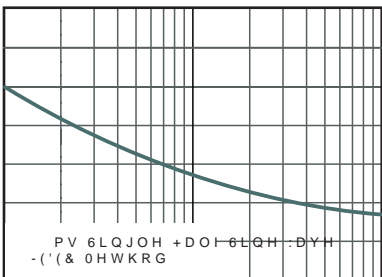

1XPEHU RI &\FOHV

AN n

A 3

3

06%PHFKDQLFWD

81,7		\$	&	'	((/	H	E	
PP	PD[f
	PLQ									
PLO	PD[
	PLQ									

06%6XJJHVWHG 3DG /D\RXW

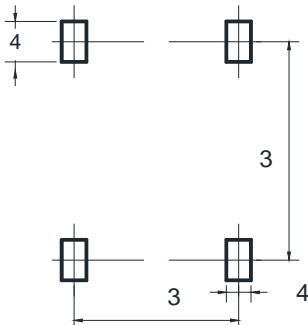

81,7		3	3	4	4
PP	PLQ				
PD	PLQ				

'LPHQVILR/QR/LOOLPHWHUV

0DUNLQJ ,QIRUPDWLRQ

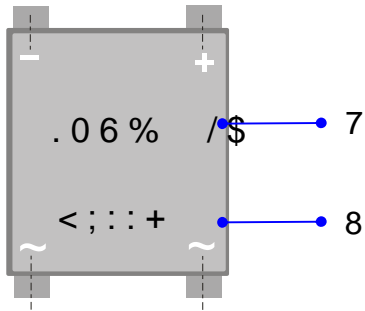

7 3URGXFW PRGHO .06% / \$
8 3' & LQIRUPDWLRQ

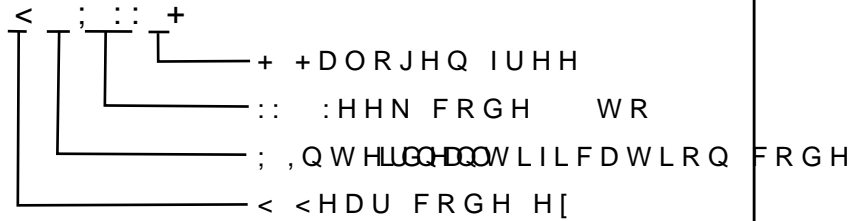

3DFNDJLQJ ,QIRUPDWLRQ

5HHO 'LPHQVLRQV

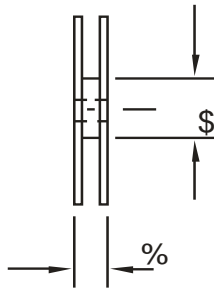
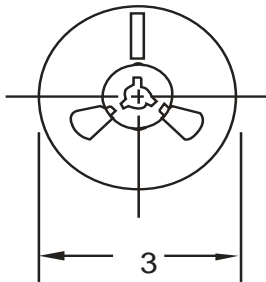

,QVLGH %R[

2XWVLGH %R[

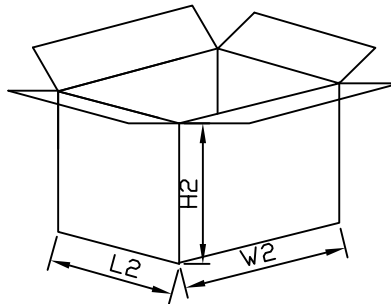
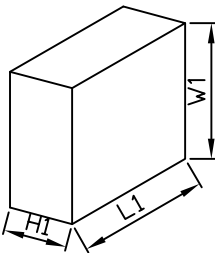

3DFNDJLQJ ,QIRUPDWLRQ

12	81,	5HHO 'LPHQVLR			,QVLGH %R[2XWVLGH %R[
			\$	%	/	:	+	/	:	+
6L]H	PP									
47<	3&6	6PDOGDFWVDJH3&6 UHHO			3&6 UHHO RWDO			3&6 FDUERPRQ RWDO		
1RWH		7ROHUDQFPP" PP			PP" PP			PP" PP		